

**Congratulations on selecting the RDR2300™ from
RCA Communications Systems - *The most trusted name in radios!***

The RDR2300 series of digital professional communications products is based on DMR technology and establishes a benchmark in premium digital two-way radio equipment. These radios are made to perform flawlessly under the most demanding commercial conditions and feature cutting edge design, high-end professional grade materials and components, simple operation and superior assembly quality. RDR2300 radios are covered by a three-year “Warranty Protection Program,” one of the most comprehensive warranties in the communications industry.

To ensure you achieve maximum performance from your RDR2300 radio, please be sure to carefully read this manual.

MODELS COVERED IN THIS MANUAL:

- RDR2300V - VHF Two-Way Radio
- RDR2300U - UHF Two-Way Radio



CONTENTS:

Technical Specifications	4-5	LED Indicator	20
Safety and General Information	6	Audio Tones	20
Product Inspection	7	Making/Receiving Calls	21 - 25
Preparing Radio For Initial Use	8	Selecting a Zone	21
Setting Up the Charger.....	8	Selecting a Channel/Subscriber ID/Group ID	18
Charging the Battery.....	8	Receiving/Responding to a Radio Call	22
Battery Storage.....	10	Receiving/Responding to a Group Call	22
Attaching the Battery.....	10	Receiving/Responding to a Private Call	22
Attaching / Removing Antenna.....	11	Receiving an All Call	23
Attaching / Removing Belt Clip.....	11	Monitoring a Channel (Analog)	23
RCA RDR2300™ Overview.....	12	Making a Radio Call	23
Connecting Audio Accessories.....	14	Making a Call W/Channel Selector Knob	24
Turn Radio On / Off.....	14	Making a Private Call	24
Adjusting the Volume.....	14	Making an All Call	25
Select a Channel	15	Group/Private Call W/One Touch Call Button	25
Programmable Buttons	15 - 17	Emergency Operation	26-27
Setting Squelch Level	17	Initiating/Responding To Emergency Alarm	26
Switching Between Analog/Digital Mode.....	17	Exiting Emergency Mode	27
Accessing Programmed Functions.....	18	Advanced Features	27-50
Operational Status Indicators	18	Radio Check	27
Display/Call Icons	19	Sending a Radio Check*	27

CONTENTS *continued*

Remote Monitor*	28	Sending a Quick Text Message.....	35
Initiating Remote Monitor*	28	Managing Fail-to-Send Text Messages.....	36
Contacts Settings*	29	Resend a Text Message.....	36
Group Call from Contacts*	29	Forwarding a Text Message.....	37
Private Call from Contacts*	30	Managing Sent Text Message	37
Call Indicator Settings/Call Tones*	30	Viewing Sent Text Messages.....	37
Call Tones for Text Messages*	31	Deleting All Sent Messages from Sent Items	38
Assigning Tone Styles*	31	Replying to an Inbox Text Message.....	38
Call Log Features*	32	Deleting a Text Message from Inbox	39
Accessing the Call Log.....	32	Privacy	39-40
Storing Alias or ID from Missed Call List.....	32	Dual Tone Multi Frequency (DTMF)	40
Deleting a Call from the Call List.....	32	Security	41-42
Call Alert Operation *	33	Radio Enable/Disable	41-42
Receiving & Responding to Call Alert.....	33	Scan	42
Making Call Alert from Contact List.....	33	Viewing an Entry in the Scan List*	43
Text Message Features*	34	Scan Instructions and Methods.....	43
Navigate to Message.....	34	Starting and Stopping Scan*	43
Receiving/Reading a Text Message	34	Responding to a Scan.....	44
Managing Received Text Messages	34		
Viewing Inbox Text Messages	35		
Writing/Sending Text Message	35		

CONTENTS *continued*

Deleting/Restoring A Nuisance Channel	44-45
Utilities	45
Keypad Locked/Unlocked*	45
Keypad Tones*	45
Setting the Power Level.....	46
Turning Voice Operating Transmission (VOX) On/ Off	46
Controlling the Display Backlight*	47
Talkaround	47
Turning Radio Tones/Alerts On or Off*	48
Turning the LED Indicator On or Off	48
Turning the Introduction Screen On or Off*	49
Accessing General Radio Information*	49-50
Care and Cleaning	50
Troubleshooting	51
Optional Accessories	52-57
FCC Caution	57
RF Exposure Compliance/Control Guidelines ..	58-59
Warranty Statement	60-61
Contact Information	62

Technical Specifications:

GENERAL	
Model	RDR2300™
Channel Numbers	32 / 1,000
Channel Spacing	Digital: 12.5KHz Analog: 12.5KHz/25KHz
Working Voltage	DC 7.5V
Frequency	VHF: 136-174MHz UHF: 400-470MHz; UHF: 450-520MHz
Operating Temperature	(-4°F)~+122°F / (-20°C)~+50°C
Storage Temperature	(-40°F)~+176°F / (-40°C)~+80°C
Weight	9.5 oz / 270 g
Size:HxWxD (Without antenna)	4.5" X 2.1" X 1.3" / 113.5mm x 54mm x 33.5mm
Waterproof Level	IP65
Digital Protocol	ETSI TS 102 361-1,-2,-3

Technical Specifications *continued:*

RECEIVE	
Frequency Stability	+/-1.0 ppm
Digital sensitivity	0.35 μ V/-116dBm (20 dB SINAD) 0.7 μ V/-110dBm (Type)
Intermodulation	TIA603C: 70 dB, ETSI: 65dB
Adjacent Channel Selectivity	TIA603C: 65dB @ 12.5kHz; ETSI: 60dB @12.5 kHz
Co-channel rejection	-8dB@12.5KHz
Spurious response rejection	70dB
Receive spurious radiation	-57dBm@<1GHz, -47dBm@>1GHz
Block	84dB
Rated Audio Power	1,000 mW @ 3% distortion

TRANSMITTER	
Transmit power	1 W, 2 W, 4/5 W; 3 programmable levels
FM noise	-40dB (12.5 kHz)
Intermodulation	60dB
Transmit spurious radiation	-36dBm@<1GHz, -30dBm@>1GHz
Adjacent channel power	-60dB@12.5KHz
Modulation limit	2.5KHz@12.5KHz
Idle slot power	-57dBm
Vocoder	AMBE3000™
Modulation Character	+1dB--(-3)dB
Digital transmission bit error rate	\leq 3%
4FSK Digital Modulation	12.5KHz Data: 7K60F1D & 7K60FXD
	12.5kHz Voice: 7K60F1E & 7K60FXE
	Combination of 12.5 kHz Voice and Data: 7K60F1W

SAFETY AND GENERAL INFORMATION

This radio is restricted to occupational use only to satisfy FCC RF energy exposure requirements. Before using this product, read the operating instructions.

- » Turn radio off prior to entering any area with a potentially explosive atmosphere, such as gas, petroleum, chemicals, blasting caps, etc.
- » Do not charge the battery in a potentially explosive atmosphere.
- » Do not use any portable radio that has a damaged antenna, as it can burn skin.
- » This equipment is to be serviced only by authorized RCA Communications Systems technicians. Any service performed by unauthorized technicians will void the warranty.
- » Turn radio off when near electrical blasting caps to avoid possible interference with blasting operations. Obey posted signs

such as those in hospitals or blasting areas advising people to turn off all two-way radios. Obey pilots and flight attendants instructions to turn off radios on airplanes.

- » Do not place a radio over an air bag or in an air bag's deployment area, as the force with which an air bag is inflated could propel the radio and may cause serious injury.
- » Do not place the radio close to a heat source or expose the radio to direct sunlight for a prolonged time.
- » Hold the radio while in use in a vertical position with the microphone one to two inches away from your lips.
- » While wearing a transmitting radio, keep the radio and its antenna at least one inch away from your body.

For a complete list of RCA approved antennas, batteries, chargers, holsters and audio accessories, visit:

<http://www.RCACommunicationsSystems.com>

PRODUCT INSPECTION

Prior to unpacking the RDR2300™ portable radio, please inspect the packaging for signs of damage and report any damage or missing components immediately to your RCA Communications Systems Sales and Service Center. Every RDR2300 portable radio comes with the following items:

Item	Qty.
RDR2300™ - Handheld Radio	1
B2017LI - Li-Ion Battery (1700 mAh)	1
ANH200U-6 - Antenna for UHF Models ANH200V-6 - Antenna for VHF Models	1
BC200 - Belt Clip	1
Instruction Manual	1
CH2001* - Desktop Rapid Charger	1
PS2001* - Power Supply	1



RDR2300™
Handheld Radio



Antenna
ANH200U-6 - UHF models
ANH200V-6 - VHF models



BC200
Belt Clip



B2017LI
Li-Ion Battery
(1700 mAh)

*Items sent in separate box if ordered.



PS2001*
Power Supply



CH2001*
Desktop Rapid Charger

Preparing Your Radio for Initial Use

Setting Up Your Charger

1. Plug the adapter's AC connector into the AC outlet socket. (see image A)
2. Plug the adapter's DC connector into the DC socket on the back of the charger. (see image B)
3. Place the radio with the battery attached, or the battery alone, in the charger. (see image C)
4. Make sure the battery contact is touching the charging terminals. The charging process begins when the red LED light illuminates.
5. The green LED light will illuminate approximately two hours later, indicating the battery is fully charged.

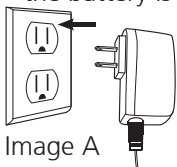

Image A

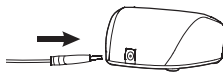
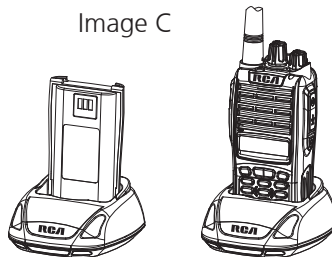

Image B

Image C



Battery Information

Charging the Battery

Your radio is powered by a Lithium-Ion (Li-Ion) battery. To avoid damage and comply with warranty terms, charge the battery using only an original RCA charger, exactly as described in the charger user guide. When the charger's LED is red, it is an indication that the battery is being correctly charged. When the LED is green, the battery charge is complete.

Note: Charge a new battery 12 to 14 hours before initial use for best performance.

Maximum battery capacity is normally achieved after two or three full charge / discharge cycles.

Caution:

To reduce the risk of injury, use only batteries specified by RCA Communications Systems.

- To avoid risk of personal injury, do not dispose of batteries in a fire.
- Dispose of batteries according to local recycling regulations. Do not dispose as household waste.
- Never attempt to disassemble the battery.
- When charging a battery, keep it at a temperature between 41°F ~ 104°F (5°C ~ 40°C) to ensure a full charge. Temperatures outside this range significantly reduce battery life. The operating time (talk-time and standby time) is noticeably shorter than normal, replace the battery.
- Before charging a battery attached to a radio, turn the radio off to ensure a full charge.

Never leave a radio on while in the charger, as it can damage both the battery and the radio; the charger is not a radio stand.

- Do not cut off the power supply or remove battery while charging.
- Never charge a battery that is wet. Dry it with soft cloth prior charging.
- The battery will eventually weaken. When the operating time (talk-time and standby time) becomes noticeably shorter than normal, replace the battery.
- Battery performance greatly decreases at temperatures below -4°F (-20°C). Having a spare battery is always necessary in extremely cold environments. A cold battery may work again when it returns to room temperature, so keep it for later use.
- Dust on the battery contact may cause the battery not to work or charge properly. Use a clean dry cloth to wipe it before attaching the battery to the radio.

- Batteries with damaged contacts can be extremely dangerous. Any battery with damage to one or more contacts should be replaced immediately and not used under any circumstances.

Battery Storage

1. Fully charge a battery before storing it for an extended period of time to avoid battery damage due to over-discharge.
2. Recharge a battery after three months storage to avoid reduced battery capacity due to over-discharge.
3. When storing a battery, keep it in a dry place at room temperature.

Attaching / Detaching the Battery

1. Place the battery so it aligns with the grooves in the back of the radio and will fit under the belt clip attachment. (See Figure 1)

2. Slide the battery towards the top of the radio until the battery clicks into place.

Note: If the battery does not securely lock with a “click”, remove it and reattach it .

3. Detaching - Push and hold the battery release button down, then slide the battery towards the bottom of the radio until the battery can be removed.

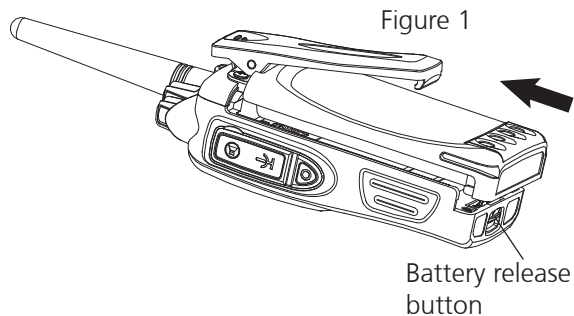

Attaching / Removing the Antenna

1. With the radio turned off, set the antenna in its receptacle and turn clockwise until it is tight. (See Figure 2)
2. To remove the antenna, turn the radio off and turn the antenna counterclockwise.

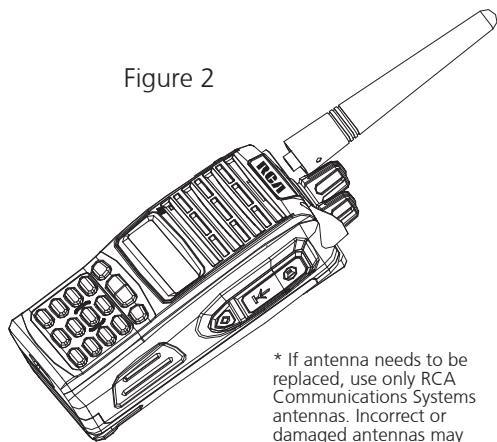

Figure 2

* If antenna needs to be replaced, use only RCA Communications Systems antennas. Incorrect or damaged antennas may reduce radio coverage

Attaching / Removing the Belt Clip

Using a small screwdriver, align the belt clip's screw holes to the radio's chassis. Attach by turning the screws clockwise into the belt clip's screw holes. Remove by doing the reverse. (See Figure 3)

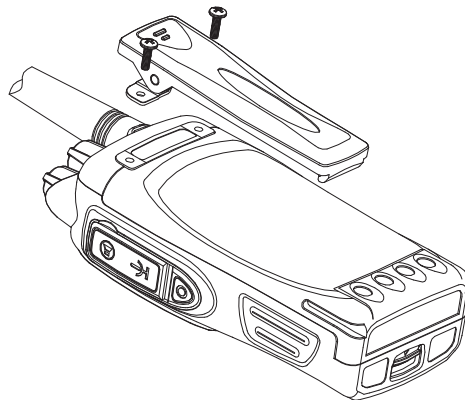
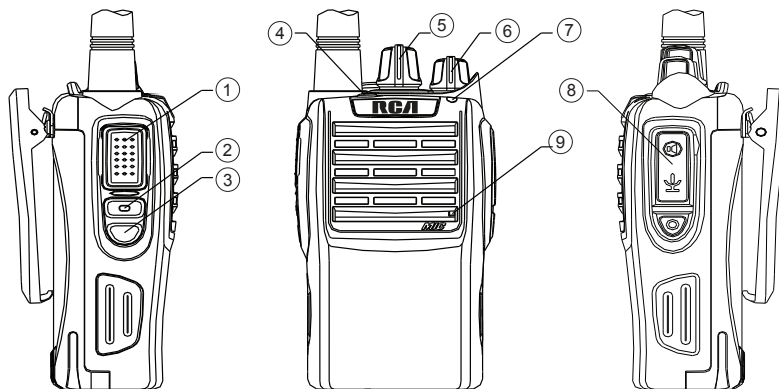

Figure 3

RCA RDR2300™ Overview



- ① Push-to-Talk (PTT) Button
- ② Programmable Button 1*
- ③ Programmable Button 2*
- ④ Programmable Button 3*
- ⑤ Channel Selector
- ⑥ On/Off/Volume Knob
- ⑦ LED Indicator
- ⑧ Audio Accessory Connector
- ⑨ Microphone

* These buttons are programmable by your RCA Communications Systems Dealer upon request.

Note: The frequency band of your RDR2300™ is on the radio label. If it is not visible, identify the frequency band according to the color circle on the antenna: white indicates UHF and red indicates VHF.

- ❶ Push-to-Talk (PTT) Button
- ❷ Programmable Button 1 *
- ❸ Programmable Button 2 *
- ❹ Microphone
- ❺ Display
- ❻ Keypad - 12 alpha/
numeric keys; 3
menu control keys
- ❼ Programmable Button 3 *
- ❽ Channel Selector
- ❾ On/Off/Volume Knob
- ❿ LED Indicator
- ⓫ Antenna
- ⓬ Belt Clip
- ⓭ Audio Accessory
Connector

* These buttons are programmable
by your RCA Communications
Systems Dealer upon request.

Connecting Audio Accessories

The audio accessory connector is located on the side of the radio under the plastic cover. It is used to connect RCA audio accessories to the radio. Pull down on the accessory cover and insert the desired audio accessory connector firmly into the accessory jack. (See Figure 4)

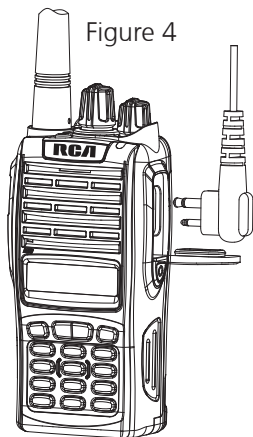

Figure 4

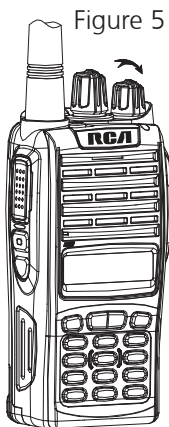

Figure 5

BASIC OPERATIONS

Turn On/Off the Radio

1. Rotate the On/Off/Volume Control Knob clockwise until you hear a click. (See Figure 5) The LED blinks orange and a brief tone sounds, indicating that the power up test is successful.
2. To turn off the radio, rotate the knob counterclockwise until you hear a click.

Note: There is no power up tone if the radio tones/alerts function is disabled. If your radio does not power up, check your battery.

Adjusting the Volume

To increase the volume, turn the On/Off/Volume Control Knob clockwise. To decrease the volume, turn this knob counterclockwise. (See Figure 5)

Select A Channel

Rotate the Channel Selector Knob to the desired

channel (Figure 6). or to switch between channels. Channels can be configured as analog or digital channel. Your radio has features that are available in both analog and digital mode. The minor differences in the way each feature works does not affect the performance of your radio.

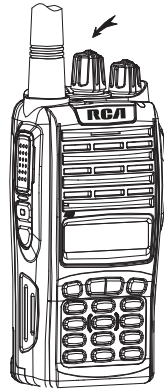

Figure 6

Programmable Buttons

Your RCA Communications Systems Dealer can program the programmable buttons as shortcuts to radio functions or preset channels/groups depending on the duration of a button press:

- Short Press - Press and release quickly.
- Long press - Press and hold for the programmed duration (between 1 seconds and 3.75 seconds).

Programmable Functions	
All Alert Tones On/Off	One Touch Access 5
Emergency On	One Touch Access 6
Emergency Off	Repeater/Talkaround
Nuisance Delete	Scan On/Off
High/Low Transmit Power	Tight/Normal Squelch
Monitor On/Off	Privacy On/Off
One Touch Access 1	VOX On/Off
One Touch Access 2	Lone Worker On/Off
One Touch Access 3	Zone Toggle (RDR2300™ only)
One Touch Access 4	Battery Indicator (RDR2300™ only)

All Alert Tones On/Off - Toggles all tones and alerts on or off.

Emergency On - Initiates an emergency alarm or call.

Emergency Off - Cancels an emergency alarm or call.

Nuisance Delete - Temporarily removes an unwanted channel, except the Selected Channel, from the scan list. The Selected Channel refers to the user's selected zone/channel combination from which scan is initiated.

High/Low Transmit Power - Toggles transmit power level between high and low.

Monitor On/Off - Monitors a selected channel for activity.

One Touch Access - Directly initiates a predefined Private or Group Call, a Call Alert or a Quick Text message.

Scan On/Off - Toggles scan on or off.
Tight/Normal Squelch - Toggles squelch level between tight and normal squelch levels.

Privacy On/Off - Toggles privacy (basic voice encryption) on or off.

VOX On/Off - Toggles Voice Activated Function on or off.

Lone Worker On/Off - Toggles Lone Worker feature On or Off, on per channel basis.

Zone Toggle (*RDR2300™ Only*) - Toggles between Channel Zone 1 and Channel Zone 2.

Battery Indicator (*RDR2300™ Only*) - Indicates battery charge level, low, medium or high.

Push-To-Talk (PTT) Button

The PTT button on the side of the radio has two main functions:

- Press and hold down PTT button to initiate and call and talk. Release the PTT button to listen. The microphone is activated when the PTT button is pressed.
- If a call is in progress, the PTT button allows the radio to transmit to the other radios that are part of the call.

Note: If the Talk Permit Tone is enabled, wait

until the short alert tone ends before talking. During a call, if the Channel Free Indication feature is enabled on your radio (programmed by your RCA Communications Systems Dealer), you will hear a short alert tone the moment the target radio (the radio that is receiving your call) releases the PTT button, indicating the channel is free for you to respond. You will also hear the Channel Free Indication tone if your call is interrupted, for example, when the radio receives an Emergency Call.

Setting the Squelch Level (Analog)

You can adjust your radio's squelch level to filter out unwanted calls with low signal strength or channels that have a higher than normal background noise.

Settings: Normal is the default level. Tight may help to filter out (unwanted) calls and / or background noise. However, calls from radio within your system that are in very remote locations may also be filtered out.

Press the programmed Squelch button to toggle squelch level between normal and tight. OR - follow the procedure below to adjust the Squelch Level through the Menu (*BR300D™ Only*):

1. Press **[O]** to access the menu.
2. Press **[<]** or **[>]** to navigate to Utilities and press **[O]** to select.
3. Press **[<]** or **[>]** to navigate to Radio Settings and press **[O]** to select.
4. Press **[<]** or **[>]** to navigate to Squelch and press **[O]** to select.
5. Choose either Tight or Normal and press **[O]** button, screen returns to the previous menu.

Switching Between Analog/Digital Mode

Each channel in your radio can be programmed as an analog channel or a digital channel. Use the Channel Selector Knob to switch between an analog or a digital channel.

Note: When switching from digital to analog, certain features of the radio become unavailable.

Accessing the Programmed Functions

You can access various radio functions one of the following ways: A short or long press of the relevant programmable buttons. OR --



- To access the main menu, press the [O] button. To toggle through the menu options, press [←] or [→].
- To select a function or access a sub-menu, press the [O] button.
- To go back one menu level, or return to the previous screen, press the [C] button.

Note: Your radio will exit the menu after a period of inactivity and returns to Main Menu.

Radio Keypad *(BR300D™ Only)*

You can use the alphanumeric keypad to access the radio features. You can also use the keypad to enter subscriber numbers or IDs, and text messages.

Note: Some characters require that you press a key multiple times. The table shows the number

of times a key needs to be pressed to generate the required character.

Operational Status Indicators

Your radio indicates its operational status through the following:

- LED Indicator
- Audio Tones

LED Indicator

The LED indicator shows the operational status of your radio.

Blinking Red - Radio is scanning, Radio is transmitting at low battery condition, receiving an emergency transmission or has failed the self-test upon powering up.

Solid Red - Radio is transmitting.

Blinking Green - Radio is powering up.

Solid Green - Radio is receiving or carrier is present/busy channel.

Rapidly Blinking Green - Radio is receiving a privacy-enabled call or data.

Note: When the LED is solid green, it indicates the radio detects activity over the air. Due to the nature of the digital protocol, this activity may or may not affect the radio's programmed channel.

Audio Tones

Alert tones provide you with audible indications of the radio's status or the radio's response to data received.

Continuous Tone - A monotone sound. Sounds continuously until termination.

Periodic Tone - Sounds periodically depending on the duration set by the radio.

Repetitive Tone - A single tone that repeats itself until it is terminated by the user.

Momentary Tone - Sounds only once for a short period of time defined by the radio.

Making and Receiving Calls

Selecting a Zone

Zones are groups of channels.

*RDR2300™ has 2 zones with a maximum of 16 channels per zone.

~~*BR300D™ has up to 250 zones with a maximum of 16 channels per zone.~~

You may switch among zones through function keys or Channel Knob as programmed by your RCA Communications Systems dealer.

1. Press the **[O]** key to access the main menu.
2. Press **[<]** or **[>]** to toggle to the Zone menu.
3. Press **[O]** to select the Zone menu.
4. Press **[<]** or **[>]** to locate the desired Zone and then press **[O]** to select the desired Zone.
5. The display will show the selected Zone momentarily.

Selecting a Channel, Subscriber ID or Group ID

Once the required zone is displayed (if your radio has multiple zones), turn the programmed Channel Selector Knob to select the channel, subscriber alias or ID, or group alias or ID.

Receiving and Responding to a Radio Call

Once the channel, subscriber ID or group ID is displayed, you can proceed to receive and respond to calls. To unscramble a privacy-enabled call, your radio must have the same Privacy Key, OR the same Key Value and Key ID (programmed by your RCA dealer), as the transmitting radio (the radio you are receiving the call from).

Receiving and Responding to a Group Call

To receive a call from a group of users, your radio must be configured to be part of the group. When you receive a Group Call:

1. The LED blinks green.
2. Press the [PTT] button to respond to the call

and the LED indicator lights up red. **Note:** If Talk Permit Function is enabled, wait for the Talk Permit Tone to finish and then speak clearly into the microphone.

3. Release the [PTT] button to listen.
4. If there is no voice activity for a set period of time, the call ends.

Receiving and Responding to a Private Call

A Private Call is a call from one individual radio to another individual radio.

There are two types of Private Calls. The first type is when a radio presence check is performed prior to setting up the call. The second sets up the call immediately. When you receive a Private Call:

1. The LED blinks green.
2. Press the [PTT] to respond to the call; the LED indicator lights up red. **Note:** If Talk Permit Function is enabled, wait for the Talk

Permit Tone to finish and then speak clearly into the microphone.

3. Release the [PTT] button to listen.
4. If there is no voice activity for a predetermined period of time, the call ends.

Receiving an All Call

An All Call is a call from an individual radio to every radio on the channel. It is used to make important announcements requiring the attention of all radio users. When you receive an All Call:

1. The LED blinks green.
2. Once the All Call ends, the radio returns to the previous screen before receiving the call.

Note: You cannot respond to an All Call. The radio stops receiving the All Call if you switch to a different channel while receiving the call.

Monitoring A Channel (Analog)

Use the Monitor feature to make sure a channel is clear before transmitting by listening for activity on the channel.

1. Press the programmed Monitor button and listen for activity. The monitor icon appears on the display.

2. If you hear activity on the channel the channel is busy. If you hear “white noise” on the channel the channel is free.

Making a Radio Call

You can select a channel, subscriber ID, or group by using:

- The Channel Selector Knob
- The programmable buttons

Making A Call With Channel Selector Knob

Making a Group Call

To make a Group Call, your radio must be configured to be part of the group.

1. Turn the Channel Selector Knob to select the channel with the active group alias or ID.
2. Press the [PTT] button to make the call. When the target radio responds, the LED lights up green.

3. Release the [PTT] button to listen.
4. If there is no voice activity for a predetermined period of time, the call ends. The radio returns to the screen you were on prior to initiating the call.

Making a Private Call

1. Turn the Channel Selector Knob to select the channel with the active subscriber alias or ID.
2. Press the [PTT] button to make the call. The LED lights up solid red. **Note:** If Talk Permit Function is enabled, wait for the Talk Permit Tone to finish and then speak clearly into the microphone.
3. If there is no voice activity for a predetermined period of time, the call ends.

Making an All Call

This feature allows you to transmit to all users on a channel. Your radio must be programmed to allow you to use this feature.

1. Turn the Channel Selector Knob to select the channel with the active All Call group alias or ID.
2. Press the [PTT] button to make the call. The LED lights up solid red.

Note: Users on the channel cannot respond to an All Call.

Making a Group or Private Call with the One Touch Call Button

The One Touch Call feature allows you to make a Group or Private Call to a predefined alias or ID easily. This feature can be assigned to a short or long programmable button press. You can only have one alias or ID assigned to a One Touch Call button. Your radio can have multiple One Touch Call buttons programmed.

1. Press the programmed One Touch Call button to make a Group or Private Call to the predefined alias or ID.
2. Press the [PTT] button to make a call. **Note:**

- If Talk Permit Function is enabled, wait for the Talk Permit Tone to finish, then speak clearly into the microphone.
3. Release the **[PTT]** button to listen. When the target radio responds, the LED blinks green.
 4. If there is no voice activity for a predetermined period of time, the calls end.

Emergency Operation

An Emergency Alarm is used to indicate a critical situation.

Your radio supports 3 Emergency Alarms:

- Emergency Alarm
- Emergency Alarm with Call
- Emergency Alarm with Voice to Follow

Each alarm has the following types:

- **Regular:** Radio transmits an alarm signal and shows audio and/or visual indicators.

- **Silent:** Radio transmits an alarm signal without any audio or visual indicators. There will be no response (call) from the target radio until you press the PTT button to initiate the call.
- **Silent with Voice:** Radio transmits an alarm signal and is able to receive an incoming call, without any audio or visual indicators, until you press the **[PTT]** button to initiate, or respond to the call.

Note: Only one Emergency Alarm can be programmed to the Emergency Button.

Initiating & Responding to Emergency Alarm

1. To initiate an Emergency Alarm, press the programmed Emergency button. The LED lights up solid red.
2. Depending on the setting selected, you can press the **[PTT]** to talk or your radio's microphone is automatically activated,

allowing you to communicate with the other radio without pressing the [PTT] button.

3. To Respond to an Emergency Alarm, press any button to stop all Emergency Alarm received indications. Press [PTT] button to initiate a call with the emergency initiating radio.

Exiting Emergency Mode

Your radio exits Emergency mode automatically when any of the following occurs:

- Emergency Alarm acknowledgement is received (for Emergency Alarm only)
- All retries to send the alarm have been exhausted
- The Emergency Off button is pressed
- The [PTT] button is pressed
- Your radio is powered off

ADVANCED FEATURES

Radio Check

If enabled, this feature allows you to determine

if another radio is active in a system without disturbing the user of that radio. No audible or visual notification is shown on the target radio.

Note: This feature is only applicable for subscriber aliases or IDs in digital mode:

Sending a Radio Check (BR300D™-Only)

Using the programmed Radio Check button:

1. Press [O] to access the menu:
2. Press [◀] or [▶] button to navigate to Contacts and press the [O] to select.
3. Press [◀] or [▶] to access the required subscriber alias or ID and press [O] to select. Or press [◀] or [▶] button to Manual Dial, then press [O], input subscriber ID.
4. Press [◀] or [▶] to Radio Check, then press [O] to select. Wait for acknowledgement.
5. The display shows Radio Check: <Subscriber Alias or ID>, indicating that Radio Check is in progress. The LED lights up red.

6. If the target radio is active in the system, a tone sounds and the display briefly shows **Target Radio Available**. OR - if the target radio is not active in the system, a tone sounds to indicate target radio not available.
7. Pressing the [C] button while the radio is waiting for acknowledgement and the radio terminates all retries and exits Radio Check.

Remote Monitor (BR300D™ Only)

Use the Remote Monitor feature to turn on the microphone of a target radio (subscriber alias or IDs only). No audible or visual indication is given to the target radio. You can use this feature to monitor, remotely, any audible activity surrounding the target radio.

Note: Your radio must be programmed by your RCA Communications Systems dealer to allow you to use the Remote Monitor feature.

Initiating Remote Monitor (BR300D™ Only)

Use the programmed Remote Monitor button:

1. Press [O] to access the main menu:

2. Press [←] or [→] to navigate to Contacts and press [O] to select.
3. Press [←] or [→] button to get the required subscriber alias or ID and press [O] button to select. OR - press [←] or [→] button to Manual Dial, then press [O]. Input subscriber alias or ID and then press [O].
4. Press [←] or [→] to Remote Monitor and press [O] button. Wait for acknowledgement.
5. The screen will display Remote Monitor: <Subscriber alias or ID>, indicating that Remote Monitor is in progress. The LED blinks red.
6. The display shows Remote Monitor Successful OR - Shows Remote Monitor Failed.
7. If successful, the radio will start receiving audio from the monitored radio for a programmed duration. Once the timer expires, the radio sounds an alert tone and the display shows Remote Monitor Ended. OR - If unsuccessful, the radio repeats the attempt until the

ADVANCED FEATURES (Continued)

programmed number of tries expires.

Contacts Settings *(BR300D™ Only)*

Contacts provide “address-book” capabilities on your radio. Each entry corresponds to an alias or ID that you can use to initiate a call. Additionally each entry, depending on context, associates with one of five types of calls: Group Call, Private Call, All Call, PC Call or Dispatch Call. Each entry within Contacts displays the following information:

- Call Type
- Call Alias
- Call ID

Note: You can add, delete, or edit contacts from the Digital Contacts list.

Group Call from Contacts *(BR300D™ Only)*

1. Press [**O**] to access the menu.
2. Press [**<**] or [**>**] button to navigate to Contacts and press [**O**] to select. All entries

are alphabetically sorted.

3. Press [**<**] or [**>**] button to select the required group alias or ID.
4. Press [**PTT**] button to make the call. The LED lights up solid red. The display shows Group Call icon, the group alias or ID, and the Group Call icon.
5. Release the [**PTT**] button to listen, when any user in the group responds, the LED blinks green. You see Group Call icon, the group ID, and that user’s ID on your display.
6. If there is no voice activity for a programmed period of time, the call ends.

Note: If Talk Permit function is enabled, wait for the Talk Permit Tone to finish and then speak clearly into the microphone.

Private Call from Contacts *(BR300D™ Only)*

1. Press [**O**] to access the menu.
2. Press [**<**] or [**>**] to navigate to Contacts and

press [O] to select.

3. Press [◀] or [▶] button to navigate to desired subscriber alias or ID. OR - Press [◀] or [▶] to Manual Dial and press [O]. Use the keypad to input the subscriber ID.
4. Press the [PTT] to make the call. The first line displays the subscriber alias or ID and the second line displays Private Call and the Private Call icon.
5. Release the [PTT] to listen. When the target radio responds, the LED blinks green and the display shows the transmitting user's ID.
6. If there is no voice activity for the programmed period of time then the call ends.

Note: If Talk Permit function is enabled, wait for the Talk Permit Tone to finish and then speak clearly into the microphone.

Call Indicator Settings – Activating And

Deactivating Call Alert Tones for Private Calls *(BR300D™ Only)*

Turn on or off the call alert tones for a received Private Call.

1. Press [O] to access the main menu.
2. Press [◀] or [▶] to Utilities and press to select.
3. Press [◀] or [▶] to Radio Settings and press [O] to select.
4. Press [◀] or [▶] to Tone/Alerts and press [O] to select.
5. Press [◀] or [▶] to Private Call and press [O] to select.
6. The display shows Turn On. Press [O] to enable Call Alert Tones. The display shows Call Alert On. OR - The display shows Turn Off. Press [O] to disable Call Alert Tones. The display shows Call Alert Off.

Activating and Deactivating Call Alert Tones for Text Messages *(BR300D™ Only)*

ADVANCED FEATURES (Continued)

Turn on or off the call alert tones for a received Text Message.

1. Press **[O]** to access the main menu.
2. Press **[<]** or **[>]** to Utilities and press **[O]** to select.
3. Press **[<]** or **[>]** to Radio Settings and press **[O]** to select.
4. Press **[<]** or **[>]** to Tone/Alerts and press **[O]** to select.
5. Press **[<]** or **[>]** to Text Message and press **[O]** to select.
6. The display shows Text Message On. OR
-The display shows Turn Off. Press **[O]** to disable Text Message. The display shows Text Message Off.

Assigning Alert Tones *(BR300D™ Only)*

You can program your radio to sound one of the predefined ring tones when receiving a Call Alert or a Text Message from a particular contact.

1. Press **[O]** to access the main menu.
2. Press **[<]** or **[>]** to Contacts and press **[O]** to select. The entries are alphabetically sorted.
3. Press **[<]** or **[>]** to the required alias or ID and press **[O]** to select.
4. Press **[<]** or **[>]** to Ring Style and press **[O]** to select.
5. A ✓ indicates the current selected tone.
6. Press **[<]** or **[>]** to the required tone and press **[O]** to select.
7. The display shows Tone <Number> Selected and a ✓ appears left of the selected tone.
OR -Press **[<]** or **[>]** to Turn Off and press to select. The display shows Text Message Tone Off and a ✓ appears left of Turn Off.

Call Log Features *(BR300D™ Only)*

Your radio keeps track of all recent outgoing, answered, and missed Private Calls. Use the call log feature to view and manage recent calls. You can Store an ID from the Call Log to Contacts or Delete it. The Call Log

lists are Missed, Answered, and Outgoing.
Note: When you select a Call List and it contains no entries, the display shows List Empty.

Accessing the Call Log

Use the programmed Remote Monitor button:

1. Press [O] to access the menu:
2. Press [←] or [→] to navigate to Call Log and press the [O] to select.
3. Press [←] or [→] to navigate to the desired list and press [O] to select. The most recent entry is displayed first.
4. Use the [←] or [→] buttons to scroll through the list.
5. After locating the desired contact, press [PTT] to initiate a call.

Storing an Alias or ID from the Missed Call List (BR300D™ Only)

1. While viewing an entry from the Call Log list press [O] to select.
2. Press [←] or [→] button to navigate to [Store]:
3. Press [O]:

4. Use the keypad to input a name:
5. Press [O] to confirm:
6. The display shows Contact Saved:

Note: You can store an ID without an Alias.

Deleting a Call from a Call List

1. While viewing an entry from the Call Log list press [O] to select:
2. Press [←] or [→] to navigate to [Delete]:
3. Press [O]:
4. Press [O] again to confirm:
5. The display shows Entry Deleted:
6. Press [O] again to return to main menu:

Call Alert Operation (BR300D™ Only)

Call Alert paging enables you to alert a specific radio user to call you back when they are able to do so. This feature is applicable for subscriber aliases or IDs only and is accessible through the menu via Contacts or Manual Dial.

Receiving and Responding to a Call Alert

When you receive a Call Alert page, on the display you see Call Alert that alternates with

ADVANCED FEATURES (Continued)

the alias or ID of the calling radio:

1. You hear a repetitive tone.
2. Press and release [PTT] button to confirm the prompt. Or - press [O] to select "Ignore?" and to exit Call Alert.

Making a Call Alert from the Contact List

(BR300D™-Only)

1. Press [O] to access the menu.
2. Press [←] or [→] to navigate to Contacts and press [O] to select.
3. Press [←] or [→] to find the desired subscriber alias or ID and press [O] to select. OR - Press [←] or [→] to the Manual Dial option and press [O].
4. Use the keypad to input the subscriber ID and press [O].
5. Use [←] or [→] to find Call Alert and press [O].
6. The display shows Call Alert: <Subscriber Alias

or ID>, indicating that the Call Alert has been sent.

7. The LED lights up red when your radio is sending the Call Alert.
8. If the Call Alert acknowledgement is received, a tone sounds and the display shows Call Alert successful. OR - If the Call Alert acknowledgement is not received, a tone sounds and the display shows Call Alert Failed.

Text Message Features *(BR300D™-Only)*

Your radio is able to receive data such as a text message from another radio. The maximum text message length is 138 characters:

Navigating to Messages *(BR300D™-Only)*

1. Press [O] to access the menu.
2. Press [←] or [→] to navigate to Messages.

Note: Press [C] button at any time to return to previous screen.

Receiving a Text Message

When your radio receives a message, the

display shows the alias or ID of the sender and the Message icon at the far left of the screen. You can select one of the following options when receiving a text message:

- Read?
- Read Later
- Delete

Reading a Text Message

1. Press [**<**] or [**>**] to navigate to [**Read?**] and press [**O**] to select.
2. Selected message in the Inbox opens. Press [**O**] to return to Home Screen or press [**<**] or [**>**] to Read Later or Delete option screen:
 - Select Read Later to return to the screen you were on prior to receiving the text message.
 - Select Delete to delete the text message.

Managing Received Text Messages

Use the Inbox to manage your text messages. The Inbox is capable of storing a maximum of

50 messages. Your radio supports the following options for text messages:

- Reply
- Forward
- Delete
- Delete-All

Text messages in the Inbox are sorted according to the date they were received.

Viewing a Text Message from the Inbox

1. Press [**<**] or [**>**] to navigate to Messages and press [**O**] to select.
2. Press [**<**] or [**>**] to navigate to Inbox and press [**O**] to select.
3. Press [**O**] to select the current message and press [**O**] again to reply, forward or delete that message. Unread messages are indicated with an exclamation mark. (!)

Writing and Sending Text Message

1. Press [**O**] to access the menu:

ADVANCED FEATURES (Continued)

2. Press [◀] or [▶] to navigate to Messages and press [O] to select.
3. Press [◀] or [▶] to navigate to Write and press [O] to select.
4. A blinking cursor appears, use the keypad to type your message. Press [◀] to move one space to the left. Press [▶] or [#] to move one space to the right. Press [*] to delete unwanted characters.
5. Press [O] once message is composed.
6. Press [◀] or [▶] to go to the required alias or ID and press [O] to select the name. OR press [◀] or [▶] to access Manual Dial and press [O]. Input subscriber ID and press [O] to confirm.
7. The radio display shows Text Message: <Subscriber/Group Alias or ID>, which confirms your message is being sent.
8. If the message is sent, a tone sounds and the display shows Message Sent. If the

message is not sent, a low tone sounds and the display shows Message Send Failed. If the text message fails to send, the radio returns you to the Resend option screen.

Sending a Quick Text Message

Your radio stores a maximum of 10 Quick Text messages as programmed by your RCA Communications Systems dealer. While Quick Text messages are predefined, you can edit each message before sending it.

1. Press [O] to access the menu.
2. Press [◀] or [▶] to navigate to Messages.
3. Press [◀] or [▶] to Quick Text and press [O].
4. Press [◀] or [▶] to find the desired Quick Text and press [O] to select.
5. A blinking cursor appears. Use the keypad to edit the message, if needed. Press [◀] to move one space to the left. Press [▶] or [#] to move one space to the right. Press [*] to delete any unwanted characters.
6. Press [O] once message is composed.

7. Press [◀] or [▶] to find the required alias or ID and press [O] to select. OR – press [◀] or [▶] to Manual Dial, press [O] to select. Input subscriber ID and press [O].
8. The display shows Text Message: <Subscriber/Group Alias or ID>, confirming your message is being sent.
9. If the message is sent successfully, a tone sounds and the display shows Message Sent. OR – If the message is not sent, a low tone sounds and the display shows Message Send Failed. If the text message fails to send, the radio returns you to the Resend option screen.

Note: Your RCA Communications Systems dealer can program a One Touch Access button to send a predefined Quick Text message to a predefined alias or ID.

Managing Fail-to-Send Text Messages (BR300D™ Only)

You can select one of the following options

while at the Resend option screen:

- Resend
- Forward
- Edit

Resending A Text Message (BR300D™ Only)

1. Press [O] to resend the same message to the same subscriber / group alias or ID.
2. If the message is sent successfully, a tone sounds and the display shows Message Sent. OR – If the message cannot be sent, a low tone sounds and the display shows Message Send Failed.

Forwarding a Text Message

1. Once in Messages, press [◀] or [▶] to navigate to Inbox and press [O] to select.
2. Press [O] and [◀] or [▶] to Forward message and press [O] to select.
3. Press [◀] or [▶] to find the required alias or ID and press [O]. OR – Press [◀] or [▶] to access Manual Dial and press [O]. Input subscriber ID then press [O] button.

ADVANCED FEATURES (Continued)

4. The display shows Text Message: <Subscriber/Group Alias or ID> confirming your message is being sent.
5. If the message is sent, a tone sounds and the display shows Message Sent. OR - If the message is not sent, a low tone sounds and the display shows Message Send Failed.

Managing Sent Text Message

Once a message is sent to another radio, it is saved in Sent Items. The most recent sent text message is always added to the top of the Sent Items list. The Sent Items folder is capable of storing a maximum of thirty (30) last sent message. When the folder is full, the next sent text message automatically replaces the oldest text message in the folder.

Viewing Sent Text Messages

1. Press [**<**] or [**>**] to navigate to Messages and

press [**O**] to select

2. Press [**<**] or [**>**] to navigate to Sent Items and press [**O**] to select.
3. Press [**<**] or [**>**] to navigate to the desired message and press [**O**] button.

You can select one of the following options while viewing a sent text message:

- Resend
- Forward
- Edit
- Delete

To perform any of the functions:

1. Press [**O**] again while viewing message.
2. Press [**<**] or [**>**] to navigate to Resend, Forward, Edit or Delete and press [**O**] to select.
3. If you select [**Resend**] or [**Edit**] and then [**Send**], the display will show Text Message: <Subscriber/Group alias or ID>, confirming that the same message is being sent to the same target radio.
4. If the message is sent, a tone sounds and

the display shows Message Sent. OR - If the message is not sent, a low tone sounds and the display shows Message Send Failed. The radio returns to the Resend option screen. Press [O] to resend the message to the same subscriber/group alias or ID:

Deleting All Sent Text Messages from Sent Items (BR300D™ Only)

1. Press [◀] or [▶] to navigate to Messages and press [O] to select.
2. Press [◀] or [▶] to navigate to Sent Items and press [O] to select.
3. Press [◀] or [▶] to navigate Delete All and press [O] to select.
4. The display shows Delete Message?, press [O] to confirm. The display shows Sent Items Cleared.

Replying to a Text Message from the Inbox

1. Press [O] to access the menu:

2. Press [◀] or [▶] to navigate to Messages and press [O] to select.
3. Press [◀] or [▶] to navigate to Inbox and press [O] to select.
4. Press [O] to select current message, and press [O] to select. Press [O] again to access the sub-menu and select Reply, Forward or Delete the message.
5. Press [◀] or [▶] to navigate to Reply and press [O] to select.
6. Press [◀] or [▶] to navigate to Write and press [O] to select. A blinking cursor appears. Use the keypad to write your message OR press [◀] or [▶] to navigate to Quick Text and press [O]. After selecting the desired message press [O] button. A blinking cursor appears. Use the keypad to edit your message, if required.
7. Press [O] to send and [O] again to confirm.
8. The display shows Text Message: <Subscriber/Group Alias or ID>, confirming

ADVANCED FEATURES (Continued)

your message is being sent.

9. If the message is sent successfully, a tone sounds and the display shows Message Sent. If the message cannot be sent, the display shows Message Send Failed. If the message fails to send, the radio returns to the Resend option screen.

Deleting a Text Message from the Inbox

1. Press [O] to access the menu.
2. Press [←] or [→] to navigate to Messages and press [O] to select.
3. Press [←] or [→] to navigate to Inbox and press [O] to select.
4. Press [O] to select current message, and press [O] to select. Press [O] again to access the sub-menu to Reply, Forward or Delete the message.
5. Press [←] or [→] to navigate to Delete and press [O] to select.

6. Press [←] or [→] to navigate to Delete and press [O] to select.
7. At Delete Message?, press [←] or [→] to navigate to Yes and press [O]. The display shows Message Deleted.

Note: When you select the Inbox and it contains no text messages, the display shows List Empty.

Privacy

If enabled, this feature helps to prevent eavesdropping by unauthorized users on a channel by the use of a software based scrambling solution. The signaling and user identification portions of a transmission are not scrambled. Your radio must have privacy enabled on the channel to send a privacy-enabled transmission, although it is not required for receiving a privacy-enabled transmission. Your radio supports two types of privacy:

- Basic Privacy

- **Enhanced Privacy**

Only ONE privacy type above can be assigned to your radio:

To unscramble a privacy-enabled call or data transmission, your radio must be programmed to have the same Privacy Key (for Basic Privacy), OR the same Key Value and Key ID (for Enhanced Privacy) as the transmitting radio.

If your radio receives a scrambled call that is of a different Privacy Key, OR a different Key Value and Key ID, you will either hear a garbled transmission (Basic Privacy) or nothing (Enhanced Privacy):

The LED lights up solid green while the radio is transmitting and blinks green rapidly when the radio is receiving an ongoing privacy-enabled transmission.

To make a private call (*BR300D™ Only*):

1. Press [**<**] or [**>**] to navigate to Utilities and press [**○**] to select.
2. Press [**<**] or [**>**] to navigate to Radio Settings

and press [**○**] to select.

3. Press [**<**] or [**>**] to navigate to Privacy and press [**○**] to select.
4. The display shows Privacy and Turn On. Press [**○**] to enable privacy. The display shows Privacy On. If the Privacy was already on the display shows Privacy and Turn Off. Press [**○**] to disable privacy. The display shows Privacy Off.

Note: This feature is available only in digital mode.

Dual Tone Multi-Frequency (DTMF)

The Dual Tone Multi-Frequency (DTMF) feature allows the radio to operate in a radio system with an interface to telephone or other DTMF based systems. DTMF Codes can be programmed into the radio by your RCA Communications Systems dealer. DTMF receive/transmit feature has four optional modes with 32 encode groups with up to 30 characters per group.

To use this feature, your radio must have an access code, which is system dependent. Please contact

ADVANCED FEATURES (Continued)

with your RCA Communications Systems dealer or system administrator for more information.

To initiate a DTMF call:

1. Press and hold PTT button.
2. Enter the desired number.

You can turn off the DTMF tone by disabling all radio tones and alerts:

Security (BR300D™ Only)

The Security Feature allows you to enable or disable any radio within your system. For example, you might want to disable a stolen radio, to preventing a thief from using it, then enable that radio once recovered. **NOTE:** The Disable/Enable feature requires your radio to have this function enabled. Check with your RCA dealer or system administrator for more information. Radio Security enables you to perform the following functions:

Radio Disable: Radio's receive / transmit

functions become disabled after the radio receives the Disable code set by your RCA Communications Systems dealer.

1. Press [0] to access the main menu.
2. Press [←] or [→] to navigate to Contacts and press [0] to select.
3. Press [←] or [→] to navigate to the desired subscriber alias or ID and press [0] to select. OR – Press [←] or [→] to navigate to Manual Dial and press [0], input subscriber ID and press [0] to select.
4. Press [←] or [→] to navigate to Radio Disable and press [0] to select.
5. The display shows Radio Disable: <Subscriber alias or ID> and LED indicator lights red.
6. Wait for acknowledgment.
7. If successful, a tone sounds and the display shows Radio Disable successful. If failed, a tone sounds and the display shows Radio Disable failed.

Radio Enable: Radio's receive / transmit

functions become enabled, when the radio is in Disable status, after the radio receives the Active code set by your RCA Communications Systems dealer. OR – Radio Enable can be initiated through the Menu of your radio:

1. Press **[O]** to access the main menu.
2. Press **[<]** or **[>]** to navigate to Contacts and press **[O]** to select. The entries are alphabetically sorted.
3. Press **[<]** or **[>]** to navigate to the desired subscriber alias or ID and press **[O]** to select. OR – You can press **[<]** or **[>]** to navigate to Manual Dial and press **[O]**, input subscriber ID and press **[O]** to select.
4. Press **[<]** or **[>]** to navigate to Radio Enable and press **[O]** to select.
5. The display shows Radio Active: <Subscriber alias or ID> and LED indicator lights red.
6. Wait for acknowledgment.
7. If successful, a tone sounds and the display shows Radio Enable successfully. If failed, a

tone sounds and the display shows Radio Enable failed:

Scan Lists

Scan lists are created and assigned to individual channels/groups. The radio scans for voice activity by cycling through the channel/group sequence specified in the scan list for the current channel/group. The RDR2300 radio has 32 scan lists with up to 16 members each and the BR300D has 250 scan lists with 16 members each. Each scan list supports a mixture of both analog and digital entries. You can add, delete, or prioritize channels by editing the scan lists:

Viewing an Entry in the Scan List (BR300D™ Only)

1. Use the Channel Selector Knob to select a channel programmed with a scan list.
2. Press **[O]** to access the menu.
3. Press **[<]** or **[>]** to navigate to Scan and press **[O]** to select.
4. Press **[<]** or **[>]** to navigate to View List and

ADVANCED FEATURES (Continued)

press **[O]** to select:

5. Use **[<]** or **[>]** to view the members on the scan list:

Note: If set as priority, the Priority icon appears left of the member's alias, indicate whether the member is on a Priority 1 or Priority 2 channel list. You cannot have multiple Priority 1 or Priority 2 channels in a scan list. There is no Priority icon if priority is set to None:

Scan Instructions and Methods

When a scan is initiated, your radio cycles through the programmed scan list for the current channel looking for voice activity. The LED blinks red and you see the Scan icon on the display (BR300D™ only):

There are two ways of initiating scan:

- **Manual Scan:** Initiate scan manually using the programmed Scan ON/OFF side button by your RCA Communications Systems dealer. OR – By

menu function (BR300D™ Only):

- When scan is initiated, radio will detect all channels/groups on the programmed scan list.
- **Auto Scan:** Your radio automatically starts scanning when you select a channel / group that has Auto Scan enabled:

Starting and Stopping Scan

Press the programmed Scan side button to start or stop the Scan. OR – Follow the procedure below (BR300D™ Only):

1. Use the Channel Selector Knob to select a channel programmed with a scan list.
2. Press **[O]** to access the menu.
3. Press **[<]** or **[>]** to navigate to Scan and press **[O]** to select.
4. The display shows Turn Off if scan is disabled or the display shows Turn on if scan is enabled.
5. Press **[O]** to select.
6. The LED blinks red and the Scan icon is

displayed when Scan is enabled. The LED turns off and the Scan icon disappears when Scan is disabled.

Responding to a Scan

During scanning, your radio stops on any channel/group where activity is detected. After the transmission is over the radio remains on the active channel for a programmed time period known as “hang time”.

1. Press the PTT button during “hang time” to respond to the call. The LED lights up red.
2. Release PTT button to listen.

Note: If you do not respond within the “hang time” period, the radio continues scanning other channels/groups.

Deleting a Nuisance Channel

If a channel continually generates unwanted calls or noise (termed a “nuisance” channel), you can temporarily remove the unwanted

channel from the scan list.

Note: This capability does not apply to the channel designated as the Selected Channel. This feature is not accessible through the menu:

1. When your radio stops on an unwanted or nuisance channel, press the programmed Nuisance Channel Delete button until you hear a tone.
2. Release the Nuisance Channel Delete button. The nuisance channel is deleted.

Restoring a Nuisance Channel

To restore the deleted nuisance channel, power the radio off and back on again. OR — Press Stop and Start to restart a scan via the programmed Scan button.

Utilities *(BR300D™ Only)*

Keypad Locked and Keypad Unlocked

You can lock your radio’s keypad to avoid an inadvertent key entry.

ADVANCED FEATURES (Continued)

1. Press [O] to access the main menu.
2. Press [◀] or [▶] to navigate to Utilities and press [O] to select.
3. Press [◀] or [▶] to navigate to Radio Settings and press [O] to select.
4. Press [◀] or [▶] to navigate to Keypad Lock and press [O] to select.
5. The display shows Keypad Locked and returns to the Home screen.

To unlock the keypad, press [O] button then press [*] button. The display shows Keypad Unlocked and returns to the Home screen.

Turning Keypad Tones On or Off

You can enable and disable keypad tones if needed:

1. Press [O] to access the main menu.
2. Press [◀] or [▶] to navigate to Utilities and press [O] to select.
3. Press [◀] or [▶] to navigate to Radio Settings

and press [O] to select.

4. Press [◀] or [▶] to navigate to Tone/Alerts and press [O] to select.
5. Press [◀] or [▶] to navigate to Keypad Tones and press [O] to select.
6. If the display shows Turn On, Press [O] to enable the keypad tones. If the display shows Turn Off press [O] to disable the keypad tones.

Setting the Power Level

You can customize your radio's power setting to high or low for each channel.

Settings:-

Press the programmed Power Level button to toggle transmits power level between high and low. OR - Follow the procedure below to adjust the Power Level through the Menu. *(BR300D™ Only)*

1. Press [O] to access the main menu.
2. Press [◀] or [▶] to navigate to Utilities and

press [O] to select.

3. Press [◀] or [▶] to navigate to Radio Settings and press [O] to select.
4. Press [◀] or [▶] to navigate to Power and press [O] button.
5. Change your current setting as prompted on the display and press [O] to select.

Press the [C] button to return to the Home screen. The display shows the Power Level icon.

Turning Voice Operating Transmission (VOX) Feature On / Off

This feature allows you to initiate a hands-free voice activated call on a programmed channel. The radio automatically transmits, for a programmed period, whenever the microphone on the VOX-capable accessory detects a voice.

Note: This feature must be programmed by your RCA dealer to enable your radios to use this function.

To begin using VOX: Press the programmed VOX button to toggle the feature on or off.

OR – Follow the procedure below to activate or deactivate VOX through the Menu. (*BR300D™ Only*)

1. Press [O] to access the menu.
2. Press [◀] or [▶] to navigate to Utilities and press [O] to select.
3. Press [◀] or [▶] to navigate to Radio Settings and press [O] to select.
4. Press [◀] or [▶] to navigate to VOX and press [O] to select.
5. If the display shows VOX On, press [O] to disable VOX. The display will change to VOX Off. OR – If the display shows VOX Off, press [O] to enable VOX and display shows VOX On.

Note: Pressing the PTT button during radio operation will disable VOX.

Controlling the Display Backlight

ADVANCED FEATURES (Continued)

(BR300D™ Only)

You can enable or disable the radio's display backlight as needed. The setting also affects the Menu navigation buttons and keypad backlighting accordingly. Press the programmed Backlight button to toggle the backlight settings. OR-

1. Press [O] to access the main menu.
2. Press [<] or [>] to navigate to Utilities and press [O] to select.
3. Press [<] or [>] to navigate to Radio Settings and press [O] to select.
4. Press [<] or [>] to navigate to Backlight and press [O] button.
5. If the display shows "Auto On". Press [O] to enable the display backlight and the display shows "Backlight Auto On". OR - If the display shows "Turn Off" press [O] to disable the display backlight and the display shows "Backlight Turn Off".

Note: The display backlight and keypad backlight are automatically turned off if the LED indicator is disabled.

Talkaround

This feature toggles between repeater and talkaround (direct) mode. If you are using a repeater and your repeater is not operating or you are out of range, you can continue to communicate during that time directly with other radios within your group. This is called "Talkaround".

Press the programmed Repeater / Talkaround button to toggle between talkaround and repeater modes. OR - follow the instructions below. *(BR300D™ Only)*

1. Press [O] to access the main menu.
2. Press [<] or [>] to navigate to Utilities and press [O] to select.
3. Press [<] or [>] to navigate to Radio Settings and press [O] to select.
4. Press [<] or [>] to navigate to Talkaround

- and press [O] to select or [C] to cancel.
5. After confirmation, the display shows "Talkaround On" OR "Talkaround Off"
 6. Press or wait the presetting time to exit the menu.
 7. The Talkaround setting is retained even after powering down.

Turning the Radio Tones/Alert On/Off

You can enable and disable all radio tones and alerts (except for the incoming Emergency alert tone) if needed. Press the programmed All Tones/Alerts button to toggle all tones on or off. *OR (BR300D™ Only) –*

1. Press [O] to access the main menu.
2. Press [←] or [→] to navigate to Utilities and press [O] to select.
3. Press [←] or [→] to navigate to Radio Settings and press [O] to select.
4. Press [←] or [→] to navigate to Tones / Alerts and press [O] to select.
5. Press [←] or [→] to navigate to All Tones and

press [O] to select.

6. If the display shows Turn On press [O] to enable all tones and alerts and the display shows All Tones On. If the display shows Turn Off press [O] to disable all tones and alerts and the display shows All Tones Off.

Turning the LED Indicator On/Off

(BR300D™ Only)

You can enable and disable the LED Indicator if needed:

1. Press [O] to access the main menu.
2. Press [←] or [→] to navigate to Utilities and press [O] to select.
3. Press [←] or [→] to navigate to Radio Settings and press [O] to select.
4. Press [←] or [→] to navigate to LED Indicator and press [O] button.
5. If the display shows Turn On, press [O] to enable the LED Indicator and the display

ADVANCED FEATURES (Continued)

shows All LEDs On. If the display shows Turn Off, press [O] to disable the LED Indicator and the display shows All LEDs Off.

Note: The display backlight, buttons and keypad backlight are automatically turned off if the LED indicator is disabled.

Turning the Introduction Screen On/Off (BR300D™ Only)

You can enable and disable the Introduction Screen if needed:

1. Press [O] to access the main menu.
2. Press [←] or [→] to navigate to Utilities and press [O] to select.
3. Press [←] or [→] to navigate to Radio Settings and press [O] to select.
4. Press [←] or [→] to navigate to Intro Screen and press [O] to select.

5. If the display shows Turn On, press [O] to enable the Introduction Screen and the display shows Intro Screen On. If the display shows Turn Off, press [O] to disable the Introduction Screen and the display shows Intro Screen Off.

Accessing General Radio Information

(BR300D™ Only)

Your radio contains information on the following:

- Radio ID
- Software version
- Codeplug Version

Checking the Radio ID

1. Press [O] to access the main menu.
2. Press [←] or [→] to navigate to Utilities and press [O] to select.
3. Press [←] or [→] to navigate to Radio Info and press [O] to select.
4. Press [←] or [→] to navigate to My Number, or Firmware Ver., or CP Ver. and press [O] button.

5. The display shows radio ID, the current firmware or the codeplug version.

ADVANCED FEATURES (Continued)

CARE AND CLEANING



- Do not directly handle the radio by its antenna or external microphone.
- Do not place the radio in a dusty or dirty environment.
- Clean the radio with a lint-free cloth moistened with clean water and/or a mild dish washing liquid to remove dirt, grease, and dust.
- Avoid subjecting the radio to corrosives, solvents or spirits.

TROUBLESHOOTING

Symptom	Solution
Radio will not power on	<ul style="list-style-type: none">a. The battery needs charging. Recharge the battery or replace it with a fresh one.b. The battery is not properly installed. Remove the battery and reattach it.
The operating time is noticeably shorter than normal even though the battery is properly charged.	<ul style="list-style-type: none">a. The battery has worn out; it is time to buy a new battery.b. The battery is not fully charged. Make sure that the battery is removed after LED indicator has turned green.
Cannot talk to or hear transmissions from your group members	<ul style="list-style-type: none">a. Make sure that your radio operates on the same channel and / or has the same CTCSS/CDCSS settings as your group members.b. Make sure you are within communication range.
Radio is on, but you cannot hear voice transmissions or they are not very loud	<ul style="list-style-type: none">a. Turn the volume control knob to its maximum volume.b. Return the radio to your dealer to check for microphone damage.

Optional Accessories

Note: Only the use of Genuine RCA accessories will guarantee compatibility and maximum performance of your radios.

	<p>3" Stubby Antenna - More compact/convenient than a 6" Antenna, but reduces coverage by approx. 30%</p> <p>VHF- ANH200V-3 136-150 VHF- ANH200V-3 150-174 UHF- ANH200U-3 400-440 UHF- ANH200U-3 440-470 UHF- ANH200U-3 450-520 UHF- ANH250U-3 450-470</p>
	<p>6" Standard Antenna - For the best reception and coverage</p> <p>VHF- ANH200V-6 136-174 VHF- ANH200V-6 150-174 UHF- ANH200U-6 400-440 UHF- ANH200U-6 440-470 UHF- ANH200U-6 450-520</p>
	<p>Multi-Unit Rapid-Rate Charger CHU6 Saves space by using one power outlet for 6 radios.</p>

Optional Accessories *continued*



Medium Duty, Remote Speaker Microphone

SM220-X03

No need to remove the radio from your waist, which helps prevent radio damage or loss.



Heavy Duty, Remote Speaker Microphone



SM310-X03

No need to remove the radio from your waist, which helps prevent radio damage or loss.

Optional Accessories *continued*

	<p>In-Ear Style, 1-Wire Surveillance Kit with In-line PTT SK11NE-X03 Professional, 1-Wire, high quality earpiece ideal for radio users requiring discreet communication</p>
	<p>In-Ear Style, 2-Wire Surveillance Kit with In-line PTT SK21NE-X03 Professional, 2-Wire, high quality earpiece ideal for radio users requiring discreet communication</p>
	<p>In-Ear Style, 3-Wire Surveillance Kit with In-line PTT SK31NE-X03 Professional, 3-Wire, high quality earpiece ideal for radio users requiring discreet communication</p>

Optional Accessories *continued*

	<p>D-Loop Style Surveillance Kit with In-line PTT SK11DL-X03 Professional, 1-Wire, high quality earpiece ideal for radio users requiring discreet communication</p>
	<p>Ear Hook Style Surveillance Kit with In-line PTT SK11EH-X03 Professional, 1-Wire, high quality earpiece ideal for radio users requiring discreet communication</p>
	<p>Lightweight Behind-The-Head Headset with In-line PTT HS11V-X03 Durable and inexpensive. Perfect for retail stores, restaurants and bars.</p>

Optional Accessories *continued*

High Noise, Over-The-Head Double Ear Headset

HS61NR-X03

For use in high noise environments such as airports, race tracks and manufacturing plants (-24dB noise reduction).



High Noise, Behind-The-Head Headset

HS71NR-X03

When a hard hat is necessary in high noise environments.



Chest Pack

CHEST-A

For those applications when securing the RDR2300™ radio to your waist is not possible.

Optional Accessories *continued***Nylon Holsters for RDR2300™****HN200FC** - Nylon Holster with fixed clip**HN200FL** - Nylon Holster with fixed belt loop**HN200SC** - Nylon Holster with swivel clip**HN200SL** - Nylon Holster with swivel belt loop**HN300FC** - Nylon Holster with fixed clip, with keypad and display**HN300FL** - Nylon Holster with fixed belt loop, with keypad and display**HN300SC** - Nylon Holster with swivel clip, with keypad and display**HN300SL** - Nylon Holster with swivel belt loop, with keypad and display**Leather Holsters for RDR2300™****HL200FC** - Leather Holster with fixed clip**HL200FL** - Leather Holster with fixed belt loop**HL200SC** - Leather Holster with swivel clip**HL200SL** - Leather Holster with swivel belt loop**HL300FC** - Leather Holster with fixed clip, with keypad and display**HL300FL** - Leather Holster with fixed belt loop, with keypad and display**HL300SC** - Leather Holster with swivel clip, with keypad and display**HL300SL** - Leather Holster with swivel belt loop, with keypad and display

FCC Caution:

Any changes or modifications not expressly approved by the party responsible for compliance could void the user's authority to operate the equipment. This device complies with part 15 of the FCC Rules. Operation is subject to the following two conditions: (1) This device may not cause harmful interference, and (2) this device must accept any interference received, including interference that may cause undesired operation.

This equipment has been tested and found to comply with the limits for a Class B digital device, pursuant to part 15 of the FCC Rules. These limits are designed to provide reasonable protection against harmful interference in a residential installation. This equipment generates uses and can radiate radio frequency energy and, if not installed and used in accordance with the instructions, may cause harmful interference to radio communications.

However, there is no guarantee that interference will not occur in a particular installation. If this

equipment does cause harmful interference to radio or television reception, which can be determined by turning the equipment off and on, the user is encouraged to try to correct the interference by one or more of the following measures:

- Reorient or relocate the receiving antenna.
- Increase the separation between the equipment and receiver.
- Connect the equipment into an outlet on a circuit different from that to which the receiver is connected.
- Consult the dealer or an experienced radio/TV technician for help.

RF Exposure Compliance and Control Guidelines and Operating Instructions

To control your exposure and ensure compliance with the occupational/controlled environment exposure limits always adhere to the following procedures.

Guidelines: Do not remove the RF Exposure Label

from the device.

User awareness instructions should accompany device when transferred to other users.

Do not use this device if the operational requirements described herein are not met.

Operating Instructions: Transmit no more than the rated duty factor of 50% of the time. To transmit (talk), push the Push-To-Talk (PTT) button. To receive calls, release the PTT button.

Transmitting 50% of the time or less is important because this radio generates measurable RF energy exposure only when transmitting (in terms of measuring for standards compliance). Hold the radio in a vertical position in front of face with the microphone (and the other parts of the radio, including the antenna) at least one inch (2.5 cm) away from the nose. Keeping the radio at the proper distance is important because RF exposures decrease with distance from the antenna. Antenna should be kept away from eyes.

When worn on the body, always place the radio in a approved clip, holder, holster, case, or body

harness for this product.

Using approved body-worn accessories is important because the use of or other manufacturer's non-approved accessories may result in exposure levels, which exceed the FCC's occupational/controlled environment RF exposure limits.

If you are not using a body-worn accessory and are not using the radio in the intended use position in front of the face, then ensure the antenna and the radio are kept at least 2.5 cm (one inch) from the body when transmitting. Keeping the radio at the proper distance is important because RF exposures decrease with increasing distance from the antenna.

Use only RCA Communications Systems approved, supplied or replacement antennas, batteries, and accessories. Use of non-approved antennas, batteries, and accessories may exceed the FCC RF exposure guidelines.

WARRANTY STATEMENT

RCA Communications Systems warrants each new radio product it supplies to be free from defects in material and workmanship under normal use and service for the time period listed below, provided that the user has complied with the requirements stated herein.

The warranty period begins on the date of purchase from an Authorized RCA Communications Systems Sales and Service Outlet. This warranty is offered to the original end user and is not assignable or transferable. RCA Communications Systems is not responsible for any ancillary equipment which is attached to or used in conjunction with RCA Communications Systems products.

RCA Communications Systems offers to the original end user a Three (3) Year Limited Warranty on the RCA RDR2300™ Radio Handset. The RDR2300™ Antenna, RDR2300™ Battery and the RDR2300™ Battery Charger are covered under a One (1) Year Limited Warranty. The RDR2300™ Belt Clip is not covered under the warranty.

During this period, if the product fails to function under normal use because of manufacturing defect(s) or workmanship, it should be returned to the Authorized RCA Communications Systems Sales and Service Outlet from which it was purchased. The Sales and Service Outlet will repair the product to full operating specifications or replace the product with a new product of the same make and model. The user is responsible for all charges incurred in returning the product to the Authorized RCA Communications Systems Sales and Service Outlet. RCA Communications Systems will be responsible for all charges in returning the product to the end user via standard ground shipping service.

RCA Communications Systems shall have no obligation to repair or replace the product, if there is damage as a result of normal wear and tear or if the damage is caused in whole or in part by catastrophe, fault or negligence of the user, improper or unauthorized alterations or repairs to the product, incorrect wiring, use of the product in a manner for which it was not designed, or by

causes external to the product. The radio equipment warranty does not cover physical or liquid damage, which includes, but is not limited to, liquid damage, damaged screen, deep scratches, bent or broken body or frame, damaged channel or volume controls, damaged antenna, charging and/or accessory ports. This warranty is void if the product serial number is altered, defaced or removed.

THE EXPRESS WARRANTIES CONTAINED HEREIN ARE IN LIEU OF ALL OTHER WARRANTIES, EITHER EXPRESSED OR IMPLIED OR STATUTORY, INCLUDING, WITHOUT LIMITATION, ANY WARRANTY OF MERCHANTABILITY OR FITNESS FOR A PARTICULAR PURPOSE.

FOR ANY PRODUCT WHICH DOES NOT COMPLY WITH THE WARRANTY SPECIFIED, THE SOLE REMEDY WILL BE REPAIR OR REPLACEMENT. IN NO EVENT WILL RCA COMMUNICATIONS SYSTEMS BE LIABLE TO THE BUYER OR ITS CUSTOMERS FOR ANY DAMAGES, INCLUDING ANY SPECIAL, INCIDENTAL, INDIRECT OR CONSEQUENTIAL DAMAGES, OR THE LOSS OF PROFIT, REVENUE OR DATA ARISING OUT OF THE USE OR THE INABILITY TO USE THE PRODUCT.

RCA Communications Systems endeavors to achieve the accuracy and completeness of this manual, but is not liable for possible omissions and/or printing mistakes.

All the above specifications and design are subject to change without prior notice.

All the reproduction and translation of this manual without authorization is prohibited.

All specifications and designs are subject to change without notice due to continuous development.

No part of this manual may be copied, reproduced, translated, stored in a retrieval system, distributed, or transmitted in any form or by any means, electronic or mechanical, for any purpose without the expressed, written permission from RCA Communications Systems.

The end-user of any two-way radio is solely responsible for obtaining any license or other authorizations required by the Federal Communications Commission (FCC). For further information visit www.fcc.gov or call 1-888-CALL-FCC (1-888-225-5322).

For Sales, Warranty and Customer Support please contact:

Advanced Radio Systems
8726 NW 26th Street Unit 6
Doral, FL. 33172
305-884-1795 www.MyRadioMall.com



www.RCACommunicationsSystems.com

Copyright © 2017 RCA Communications Systems